



GÜVENAL

E L A S T O M E R



EN **BÜYÜK**
KAZANÇ
ALDIĞINIZ
GÜVENDİR

TIME IS THE GREATEST GAIN

Hakkımızda

Güvenal Lastik, 1982 yılında İstanbul'da kuruldu. Elektrik ve Otomotiv sektöründe her türlü oring, conta, profil lastik ile standart üretimin yanısıra özel siparişlere de yer vermektedir. İmalatımız kendi bünyemizde kalifiyeli personelimizle birlikte yapılmaktadır. Kaliteden hiçbir zaman ödün vermemiş olan Güvenal Lastik, kalitesini "ISO 9001:2008 Kalite Sistem Belgesi"ni alarak belgelendirmiştir.

Güvenal, üstün kaliteyi, sorunsuz hizmeti ve müşterilerine verdiği güveni kendisine ilke edinmiştir. Sürekli gelişim ve değişimi takip ederek, sizlerin talepleri doğrultusunda mermer sektörüne de 1995'li yıllarda adım atmıştır.

Biliyoruz ki sizler binbir emek ve güçle çok değerli bir hazine olan mermeri yeryüzüne çıkarıyorsunuz. Ülkemize ve dünyamıza büyük hizmet sunuyorsunuz. Biz de sizin bu yükünüzü hafifletmek için sağlam ve dayanıklı ürünlerle mermer ocaklarında olduğu gibi fabrikalarınızda da hertürlü ebatlarda akordion bez ve kauçuk körükler, vakum lastikleri, kaplinler, çamur pompa lastikleri ve makara çeşitleri ile yanınızdayız.

Güvenal Lastik, "EN BÜYÜK KAZANÇ ZAMANDIR" düşüncesiyle mermer bloklarını ayırmada işinizi kolaylaştıracak, maliyetleri azaltacak ilk yerli üretim hava yastıklarını sizlere özel tasarımla üretmiştir.

Bugün mermer sektöründe rekor denilebilecek sayıda müşteri portföyüne sahip olan Güvenal Lastik, tüm yurt genelinde ve yurtdışında her zaman kalite güvencesiyle sizlere hizmet vermekten mutluluk duyar..

About Us

Güvenal Lastik, was founded in İstanbul in 1982. Electric and Automotive industries, all kinds of O-ring, seal, rubber are produced in standard and on special demand. Production is made in our facilities with our qualified personnel. High quality has always been the biggest aim for Güvenal Lastik, and certified this by "ISO 9001:2008 Quality System Certificate".

Güvenal has accepted high quality, precise service and trust on customers as principle. By continuous progress with your demands Güvenal has penetrated marble industry in 1995.

We know that; you serve the world by surfacing very valuable marble with hard efforts. We produce durable marble products for marble production quarries and factories. A wide variety of products like accordion cloth and rubber bellows, vacuum rubber, caliber rubber, mud pump rubber and PVC rollers are produced in our factory.

By considering the principle "TIME IS THE BIGGEST GAIN", we produced our special design airbags that are used to separate the marble blocks that will ease your work and decrease the costs.

Today in marble industry Güvenal has big portfolio of inland and international customers.



İÇİNDEKİLER / CONTENTS

Hava Yastığı Grubu / Airbag Group	2
Blok Sabitleme Hava Yastığı Grubu / Fastening Airbag For Gangsaw Machine Group	3
Tel Kasnak Lastik Grubu / Flywheel Rubber Group	4
Tel Kasnak Lastik Çember Grubu / Flywheel Rubber Ring Group	5
Makara Grubu / Ruller Group	6
Plastik Yardımcı Grubu / Plastic Auxiliary Group	7
Kaplin Grubu / Calibber Rubber Group	8
Vakum Grubu / Vacuum Group	9
Silikon Vakum Grubu / Silicon Vacuum Group	
Çamur Pompa Grubu / Rubber For Mud Pumps Group	10
Dozaj Diyafram Lastik Grubu / Dosage Aperture Rubber Group	
Vana Lastik Grubu / Rubber For Valve Group	11
Makine Körük Grubu / Rubber Bellows Group	12
Akordeon Körük Grubu / Accordeon Cloth Group	13
Baskı Lastik Grubu / Press Rubber Group	14
Dolgu Silim Lastik Grubu / Marble Grabbing Rubber Group	
Bağlantı Takoza Grubu / Stone Grabbing Apparatus Group	
Kapma Lastik Grubu / Grab Rubber Group	15
Palet Lastik Grubu / Palet Rubber Group	
Dizgi Lastik Grubu / String Rubber Group	16
Dizgi Kesim Kalıbı Grubu / String Cutting Rubber Group	17

HAVA YASTIĞI GRUBU

AIRBAG GROUP

Mermer ocaklarında mermer bloklarını ayırmak için kullanılan ve ilk yerli üretimi Güvenal Lastik tarafından gerçekleştirilen hava yastığı; kullanımda kolaylık, zamandan tasarruf, firesiz üretim ve defalarca kullanım özelliği ile üretim maliyetlerinizi azaltmaktadır. Her mermer ocağı için fonksiyonel olan hava yastığı 2 standart boyutta, 10 mm tel kesim aralığına girecek şekilde tasarlanmıştır. 100x100 cm ebatındaki 5-10 cm taşı aralarken, 230x170 cm ebatındaki hava yastığı 30-35 cm taşı ayırmaktadır. Hava kontrol ünitesi ise; basınç ayar saatleri, 3 adet otomatik subapla donatılmış ve ürünler 3 ATM basınçla emniyetli olarak kullanımı sağlanmıştır. Ayrıca bozuk satırlar için en üst yüzeye koruyucu sac, iç yüzeyler için koruyucu lastik ekipmanlıdır.

Airbag is used in marble quarries for separating marble blocks. It decreases your costs by its easy use with no wastage and can be used for several times, and saves your time. It is functional for every marble quarry with two standard dimensions. It is designed for entering 10 mm of wire cutting gap. The bag with 100x100 cm size separates the block for 5-10 cm, and the bag with 230x170 cm separates the block for 30-35 cm. Air Control Panel works with three automatic valves and operates with 3 ATM pressure safely. When there are rough surfaces, for the upper most face, protecting sheet metal and for the inner faces, protecting rubber is included as an equipment.

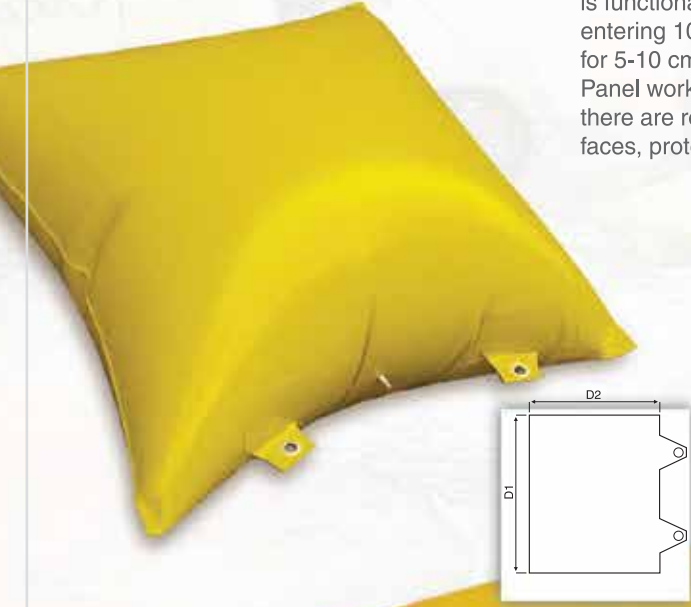

Kod Code	Açıklama Description	D1	D2
310301	Hava Yastığı Küçük Boy / Air Bag Small	100 cm	100 cm
310302	Hava Yastığı Büyük Boy / Air Bag Big	230 cm	170 cm
310303	Kontrol Panel / Air Control Panel		



Hava Yastığı Uygulama Süreci / Airbag Application Process



BLOK SABİTLEME HAVA YASTIĞI GRUBU

FASTENING AIRBAG FOR GANGSAW MACHINE GROUP

Katrak makinelerinde blok kesme işlemi gerçekleşirken blok sabitleme hava yastığı ile bloğun alın bölgesinde destekleyici konumunda bağlanarak bloğu sarsıntılara ve darbelere karşı korur böylece bloğun düzgün, kolay ve sesi en aza indirerek rahat bir şekilde kesilmesini sağlar ayrıca sarsıntı olmadığı için katrak makinesinde kullanılan kesim elmaslarının kullanım ömrü ve verimliliğini artırır.

Katrak Sabitleme Hava Yastığı'nın bir başka amacı ise blok kesilmeye başladıktan bir süre sonra yapılan ve çalışanın zamanını alan Kamalama prosesini ortadan kaldırmaktır. Sabitleme hava yastığı ile Kamalama'ya gerek kalmadan rahat ve kolay bir biçimde blok kesimi gerçekleştirilir.

Ayrıca Sabitleme Hava Yastığı'nın Katrak makinesine takılması ve uygulanması kamalama işleminden daha kolay, hızlı ve çalışan için daha güvenlidir.

Katrak Blok Sabitleme Hava Yastığı'nın Faydaları:

1. Kamalama süresinin ortadan kalkması, daha hızlı bir şekilde blok kesme işleminin yapılması ve üretimin artması.
2. Bloğu sarsıntılara ve darbelere karşı koruyarak zarar görmesinin engellenmesi.
3. Kesim elmaslarını sarsıntılara ve darbelere karşı koruyarak zarar görmelerinin engellenmesi ve kesim elmaslarının kullanım sürelerinin, verimliliklerinin artırılması.
4. Sabitleme Hava Yastığı'nın Katrak makinesine takılması ve uygulanması kolay, hızlı ve çalışan için daha güvenlidir.

The Benefits Of The Fastening Air-Bags:

1. It does not require lagging, it cuts the blocks so much faster; therefore, it increases the production.
2. It protects the marble blocks from harm that is caused by the concussions and the strokes.
3. It protects the diamond wire gangsaws from harm that is caused by the concussions and the strokes; increases the efficiency of the gangsaw and helps it last longer.
4. It provides a better method for placing the air-bags on the gangsaws; it is simpler, faster and safer.



TEL KASNAK LASTİK GRUBU

FLYWHEEL RUBBER GROUP



Güvenal, mermer blok kesme makinalarında kullanılan, aşınmaya karşı dayanıklı, makinanızın çalışma kapasitesini artıran, uzun ömürlü kullanımı ile, istenilen kesitte, istenilen ebatta metre ve çember olarak kasnak lastikleri üretmektedir.

Güvenal produces flywheel rubbers that are used in marble cutting machines. Our rubbers are corrosion resistant with long life and can be produced in every cross section, length, diameter and dimension.

Kod Code	Tanım Description	Ölçü Dimension
310101	Tel Lastik V1 / Flywheel Rubber V1	-
310102	Tel Lastik V2 / Flywheel Rubber V2	-
310103	Tel Lastik UV2 / Flywheel Rubber UV2	-
310104	Tel Lastik Y / Flywheel Rubber Y	-
310105	Tel Lastik MK&DT / Flywheel Rubber MK&DT	50x30 mm
310106	Tel Lastik DL&MH / Flywheel Rubber DL&MH	48x30 mm
310107	Tel Lastik KP&HB / Flywheel Rubber KP&HB	49x30 mm
310108	Tel Lastik / Flywheel Rubber	45x30 mm
310109	Tel Lastik / Flywheel Rubber	40x30 mm
310110	Tel Lastik / Flywheel Rubber	36x30 mm
310111	Tel Lastik / Flywheel Rubber	30x30 mm
310112	Tel Lastik Marini Kauçuk / Flywheel Rubber Marini Rubber	40x8 mm
310113	Tel Lastik Marini Poliüretan / Flywheel Rubber Marini Polyurathane	40x8 mm
310114	Tel Lastik Marini Tırnaklı / Flywheel Rubber Marini Spiked	40x8 mm
310115	Tel Lastik / Flywheel Rubber	50x32 mm

TEL KASNAK LASTİK ÇEMBER GRUBU

FLYWHEEL RUBBER RING GROUP



310212



310213



310214

Kod Code	Tanım Description	Ölçü Dimension
310201	Tel Lastik Çember / Flywheel Rubber Ring	80x70 cm
310202	Tel Lastik Çember / Flywheel Rubber Ring	60x50 cm
310203	Tel Lastik Çember / Flywheel Rubber Ring	50x40 cm
310204	Tel Lastik Çember / Flywheel Rubber Ring	41x32 cm
310205	Tel Lastik Çember / Flywheel Rubber Ring	90x80 cm
310206	Tel Lastik Çember / Flywheel Rubber Ring	79x70 cm
310207	Tel Lastik Çember / Flywheel Rubber Ring	50x42 cm
310208	Tel Lastik Çember / Flywheel Rubber Ring	42x35 cm
310209	Tel Lastik Çember Klavuz / Flywheel Rubber Ring Guide Pin	34x25 cm
310210	Tel Lastik Çember Klavuz / Flywheel Rubber Ring Guide Pin	30x24 cm
310211	Tel Lastik Çember Klavuz Poliüretan / Flywheel Rubber Ring Guide Pin Polyurathane	30x24 cm
310212	Tel Lastik Çember Avare 8 Delik / Flywheel Rubber Ring Avare 8 Hole	17 cm
310213	Tel Lastik Çember Avare Poliüretan 8 Delik / Flywheel Rubber Ring Avare Polyurathane 8 Delik	20 cm
310214	Tel Lastik Çember Avare Poliüretan 3 Delik / Flywheel Rubber Ring Avare Polyurathane 3 Delik	17 cm
310215	Tel Lastik Çember Pimli 100 / Flywheel Rubber Ring Pin 100	100 cm
310216	Tel Lastik Çember / Flywheel Rubber Ring	80x71 cm
310217	Tel Lastik Çember Avare 3 Delik / Flywheel Rubber Ring Avare 3 Delik	20 cm
310218	Tel Lastik Çember Klavuz / Flywheel Rubber Ring	38x32 cm



MAKARA GRUBU

RULLER GROUP



310401



310406 - 310407

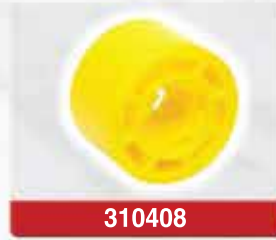

310408



310409



310410



310413 - 310414



310415



310416

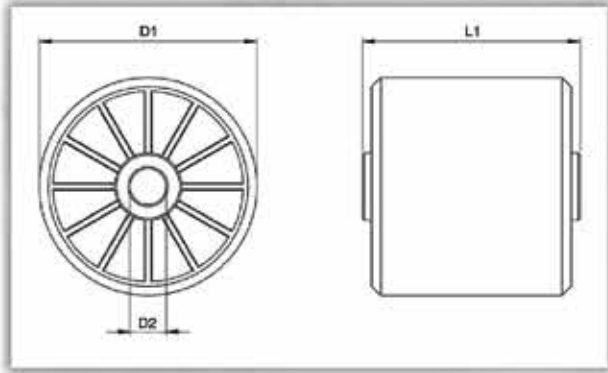

Kod Code	Tanım Description	D1	D2	L1
310401	Makara / Roller	120 mm	20 mm	120 mm
310402	Makara / Roller	110 mm	25,5 mm	65 mm
310403	Makara / Roller	110 mm	20,5 mm	65 mm
310404	Makara / Roller	100 mm	25,5 mm	65 mm
310405	Makara / Roller	100 mm	20 mm	65 mm
310406	Makara Tırnaklı / Roller Claw	100 mm	30 mm	65 mm
310407	Makara Tırnaklı / Roller Claw	80 mm	20,5 mm	32 mm
310408	Makara Tırnaklı / Roller Claw	50 mm	20,5 mm	32 mm
310409	Makara / Roller	80 mm	20 mm	105 mm
310410	Makara / Roller	80 mm	25 mm	105 mm
310411	Makara / Roller	80 mm	25 mm	85 mm
310412	Makara / Roller	60 mm	20 mm	65 mm
310413	Makara / Roller	60 mm	30 mm	93 mm
310414	Makara / Roller	60 mm	35,5 mm	93 mm
310415	Makara Kademeli / Roller Stepping	60 mm	20 mm	95 mm
310416	Makara Kauçuk Kaplı / Roller Covered in Rubber	65 mm	20 mm	65 mm

PLASTİK YARDIMCI GRUBU

PLASTIC AUXILIARY GROUP



310417 - 310418



310420



310421



310422



310423



310424



310425



310426



310427



310429



310430



310431

Kod Code	Tanım Description	Ölçü Dimension		
310417	Makine Parçası Dayama Plastik / Machine Part Support Lean Plastic	36 mm	14,5 mm	36 mm
310418	Dayama Plastik / Machine Part Support Lean Plastic	38 mm	15 mm	60 mm
310419	Tırnaklı Kilit / Auxiliary Group Lock Claw	80 mm	30 mm	45 mm
310420	Kilit / Auxiliary Lock	80 mm	30 mm	20 mm
310421	Tırnaklı Kilit / Auxiliary Group Claw	45 mm	20 mm	30 mm
310422	Tırnaklı Kilit / Auxiliary Group Claw	80 mm	30 mm	30 mm
310423	Mermer Kaması / Auxiliary Group Marble Wedge	-	-	-
310424	Çakma Kama Plastik / Auxiliary Group Marble Wedge PVC	200 mm	30 mm	-
310425	Üçgen Destek / Auxiliary Group Support Triangle	100 mm	40 mm	150 mm
310426	Köşe Plastiği / Auxiliary Group Corner PVC	-	-	-
310427	Kırlangıç (Taş Baçlangıç Kızağı) / Auxiliary Group Dovetail	-	-	-
310428	Kauçuk Baskı Lastik Plastik / Auxiliary Group Rubber Press Rubber PVC	22 mm	15 mm	88 mm
310429	Rulman Yatağı Kare / Auxiliary Group Rulman Square	50 mm	35 mm	50 mm
310430	Rulman Yatağı / Auxiliary Group Rulman	50 mm	32 mm	60 mm
310431	Ara Parça / Auxiliary Group Connector	28 mm	20,5 mm	40 mm

KAPLIN GRUBU

CALIBBER RUBBER GROUP

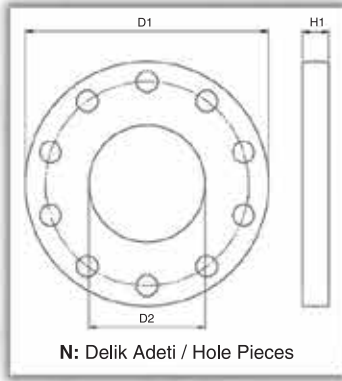

Kod Code	Tanım Description	D1	D2	H1	N
3112001	Kaplin / Caliber Rubber	230 mm	125 mm	20 mm	8
3112002	Kaplin / Caliber Rubber	250 mm	140 mm	30 mm	6
3112003	Kaplin / Caliber Rubber	230 mm	120 mm	20 mm	10
3112004	Kaplin / Caliber Rubber	210 mm	140 mm	30 mm	6
3112005	Kaplin / Caliber Rubber	250 mm	150 mm	30 mm	8
3112006	Kaplin / Caliber Rubber	300 mm	130 mm	30 mm	10
3112007	Kaplin / Caliber Rubber	210 mm	140 mm	25 mm	6
3112008	Kaplin / Caliber Rubber	180 mm	70 mm	25 mm	6
3112009	Kaplin / Caliber Rubber	195 mm	80 mm	-	4
3112010	Kaplin / Caliber Rubber	210 mm	90 mm	25 mm	8
3112011	Kaplin / Caliber Rubber	250 mm	135 mm	25 mm	8
3112012	Kaplin / Caliber Rubber	230 mm	140 mm	20 mm	10
3112013	Kaplin / Caliber Rubber	200 mm	80 mm	25 mm	8
3112014	Kaplin Kademeli / Caliber Rubber Stepping	280 mm	120 mm	30 mm	-
3112015	Kaplin / Caliber Rubber	200 mm	60 mm	30 mm	6
3112016	Kaplin / Caliber Rubber	230 mm	125 mm	20 mm	10
3112017	Kaplin / Caliber Rubber	300 mm	130 mm	20 mm	10
3112018	Kaplin / Caliber Rubber	230 mm	110 mm	20 mm	10
3112019	Kaplin / Caliber Rubber	330 mm	235 mm	25 mm	15
3112020	Kaplin / Caliber Rubber	260 mm	190 mm	35 mm	12
3112022	Kaplin / Caliber Rubber	230 mm	105 mm	20 mm	6
3112023	Kaplin / Caliber Rubber	230 mm	110 mm	20 mm	8
3112024	Kaplin / Caliber Rubber	240 mm	70 mm	20 mm	12
3112025	Kaplin / Caliber Rubber	165 mm	55 mm	25 mm	6
3112026	Kaplin / Caliber Rubber	230 mm	135 mm	20 mm	10
3112027	Kaplin / Caliber Rubber	205 mm	55 mm	25 mm	8
3112028	Kaplin / Caliber Rubber	280 mm	135 mm	20 mm	6
3112029	Kaplin / Caliber Rubber	280 mm	80 mm	20 mm	10
3112030	Kaplin / Caliber Rubber	180 mm	65 mm	25 mm	6
3112031	Kaplin / Caliber Rubber	355 mm	40 mm	25 mm	8
3112032	Kaplin / Caliber Rubber	140 mm	170 mm	20 mm	8
3112033	Kaplin / Caliber Rubber	370 mm	95 mm	30 mm	12
3112034	Kaplin / Caliber Rubber	240 mm	140 mm	30 mm	6
3112035	Kaplin / Caliber Rubber	190 mm	55 mm	25 mm	8
3112036	Kaplin / Caliber Rubber	260 mm	90 mm	25 mm	12
3112037	Kaplin / Caliber Rubber	260 mm	100 mm	15 mm	-

* Talep edilen ölçü ve ebatlarda üretim yapılmaktadır.
* Products can be desired extent size.

VAKUM GRUBU

VACUUM GROUP



3114101



3114106



3114107



3114111



3114115



3114116



3114118



3114119

Kod Code	Tanım Description	Ölçü Dimension
3114101	Vakum Aparatı / Vacuum Equipment	-
3114102	Vakum Demirli / Vacuum Anchored	155 mm
3114103	Vakum / Vacuum	150 mm
3114104	Vakum / Vacuum	185 mm
3114105	Vakum / Vacuum	140 mm
3114106	Vakum / Vacuum	170 mm
3114107	Vakum / Vacuum	60 mm
3114108	Vakum / Vacuum	145 mm
3114109	Vakum / Vacuum	155 mm
3114110	Vakum / Vacuum	160 mm
3114111	Vakum / Vacuum	90 mm
3114112	Vakum / Vacuum	250 mm
3114113	Vakum / Vacuum	300 mm
3114114	Vakum Kaplama / Vacuum	250 mm
3114115	Vakum / Vacuum	110 mm
3114116	Vakum / Vacuum	80 mm
3114117	Vakum / Vacuum	145-30 mm
3114118	Vakum Gri / Vacuum Grey	200 mm
3114119	Vakum Tırnaklı / Vacuum Teeth	90 mm

SİLİKON VAKUM GRUBU

SILICON VACUUM GROUP



3114204



3114206

Kod Code	Tanım Description	Ölçü Dimension
3114201	Silikon Vakum / Silicon Vacuum	300 mm
3114202	Silikon Vakum Demirli / Silicon Vacuum Anchored	155 mm
3114203	Silikon Vakum Demirli / Silicon Vacuum	200 mm
3114204	Silikon Vakum Konik / Silicon Vacuum Conic	90 mm
3114205	Silikon Vakum / Silicon Vacuum	125 mm
3114206	Silikon Vakum / Silicon Vacuum	250 mm
3114207	Silikon Vakum Kaplama / Silicon Vacuum Covering	250 mm
3114208	Silikon Vakum / Silicon Vacuum	110 mm
3114209	Silikon Vakum / Silicon Vacuum Grey	200 mm

ÇAMUR POMPA GRUBU

RUBBER FOR MUD POMPS GROUP



3 Kanatlı Pervane
Screw Propeller with 3 Flaps



4 Kanatlı Pervane
Screw Propeller with 4 Flaps



Çamur Pompa Gömlek Lastiği
Rubber for Mud Pumps



Çamur Pompa Gömlek Lastiği
Rubber for Mud Pumps

DOZAJ DİYAFRAM LASTİK GRUBU

DOSAGE APERTURE RUBBER GROUP

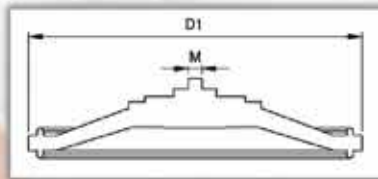

Kod Code	Tanım Description	Metrik Metric	D1
311701	Dozaj Diyafram Lastik / Dosage Aperture Rubber	6 mm	150 mm
311702	Dozaj Diyafram Lastik / Dosage Aperture Rubber	6 mm	155 mm
311703	Dozaj Diyafram Lastik / Dosage Aperture Rubber	8 mm	155 mm
311704	Dozaj Diyafram Lastik / Dosage Aperture Rubber	8 mm	135 mm

VANA LASTİK GRUBU

RUBBER FOR VALVE GROUP



310803 - 310810
310812 - 310813
310814



310801 - 310809



310811



310808

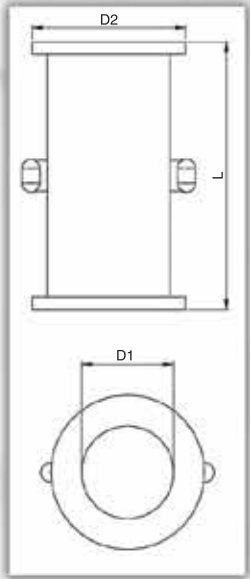

Kod Code	Tanım Description	D1	D2	L
310801	Vana Gmlek Lastik - Vidalı / Rubber For Valve - Nut	150 mm	240 mm	335 mm
310802	Vana Gmlek Lastik - Dz / Rubber For Valve - Flat	150 mm	240 mm	335 mm
310803	Vana Gmlek Lastik - Kelebek / Rubber For Valve - Butterfly	150 mm	240 mm	330 mm
310804	Vana Gmlek Lastik - Dz / Rubber For Valve - Flat	50 mm	110 mm	350 mm
310805	Vana Gmlek Lastik - Dz / Rubber For Valve - Flat	95 mm	150 mm	245 mm
310806	Vana Gmlek Lastik - Dz / Rubber For Valve - Flat	65 mm	-	200 mm
310807	Vana Gmlek Lastik - Dz / Rubber For Valve - Flat	140 mm	290 mm	400 mm
310808	Vana Gmlek Lastik - Vidalı / Rubber For Valve - Nut	30 mm	60 mm	170 mm
310809	Vana Gmlek Lastik - Vidalı / Rubber For Valve - Nut	40 mm	80 mm	210 mm
310810	Vana Gmlek Lastik - Kelebek / Rubber For Valve - Butterfly	95 mm	155 mm	245 mm
310811	Vana Gmlek Lastik - Somunlu / Rubber For Valve - Nut	200 mm	300 mm	380 mm
310812	Vana Gmlek Lastik - Kelebek / Rubber For Valve - Butterfly	85 mm	85 mm	200 mm
310813	Vana Gmlek Lastik - Kelebek / Rubber For Valve - Butterfly	150 mm	230 mm	360 mm
310814	Vana Gmlek Lastik - Kelebek / Rubber For Valve - Butterfly	150 mm	90 mm	245 mm
310815	Vana Lastik / Rubber For Valve	140 mm	330 mm	-

MAKİNE KÖRÜK GRUBU

RUBBER BELLOWS GROUP

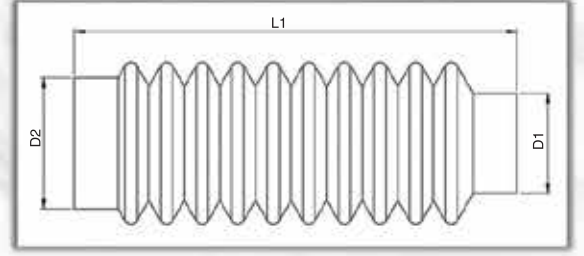

Kod Code	Tanım Description	D1	D2	L
311000	Makine Körük Muhtelif / Rubber Below Common	-	-	-
311001	Makine Körük / Rubber Below	30 mm	40 mm	150 mm
311002	Makine Körük (Kare) / Rubber Below (Square)	30 mm	40 mm	60 mm
311003	Makine Körük / Rubber Below	40 mm	40 mm	200 mm
311004	Makine Körük / Rubber Below	40 mm	60 mm	200 mm
311005	Makine Körük / Rubber Below	100 mm	130 mm	200 mm
311006	Makine Körük / Rubber Below	125 mm	125 mm	200 mm
311007	Makine Körük / Rubber Below	185 mm	185 mm	1000 mm
311008	Makine Körük / Rubber Below	185 mm	185 mm	1200 mm
311009	Makine Körük / Rubber Below	170 mm	210 mm	1000 mm
311010	Este Körük / Este Below	200 mm	200 mm	800 mm
311011	Makine Körük / Rubber Below	210 mm	210 mm	210 mm
311012	Makine Körük / Rubber Below	200 mm	240 mm	200 mm
311013	Makine Körük / Rubber Below	105 mm	105 mm	40 mm
311014	Makine Körük / Rubber Below	85 mm	180 mm	250 mm
311015	Makine Körük / Rubber Below	100 mm	200 mm	250 mm
311016	Makine Körük / Rubber Below	220 mm	220 mm	1000 mm
311017	Makine Körük / Rubber Below	100 mm	100 mm	200 mm
311018	Makine Körük / Rubber Below	180 mm	180 mm	150 mm

* Talep edilen ölçü ve ebatlarda üretim yapılmaktadır.
* Products can be desired extent size.

AKORDEON KÖRÜK GRUBU

ACCORDEON CLOTH GROUP

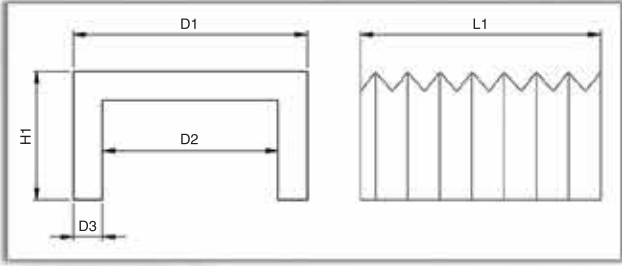

* Talep edilen ölçü ve ebatlarda üretim yapılmaktadır.
* Products can be desired extent size.



BASKI LASTİK GRUBU

PRESS RUBBER GROUP

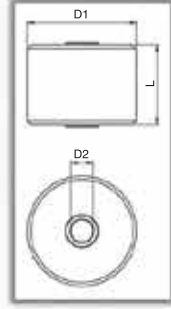

Kod Code	Tanım Description	D1	D2	L
311501	Baskı Lastik (Burçlu) / Press Rubber (Bushing)	80 mm	17 mm	60 mm
311503	Baskı Lastik Poliüretan (Burçlu) / Press Rubber Polyurethane (Bushing)	80 mm	17 mm	60 mm
311504	Baskı Lastik / Press Rubber	80 mm	17 mm	50 mm
311505	Baskı Lastik Poliüretan / Press Rubber Polyurethane	100mm	35 mm	94 mm
311506	Baskı Lastik / Press Rubber	100 mm	20 mm	67 mm
311507	Baskı Lastik Burçlu / Press Rubber (Bushing)	100 mm	17 mm	67 mm

DOLGU SİLİM LASTİK GRUBU

MARBLE GRABBING RUBBER GROUP

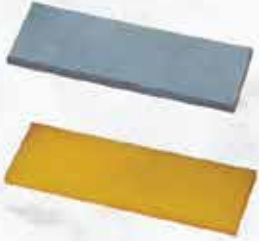

Kod Code	Tanım Description	D1	L	H
310601	Dolgu Silim Plaka Kauçuk / Abrading Rubber	100 mm	300 mm	10 mm
310602	Dolgu Silim Plaka Kauçuk / Abrading Rubber	100 mm	1000 mm	10 mm
310603	Dolgu Silim Plaka Kauçuk / Abrading Rubber	120 mm	280 mm	12 mm
310604	Dolgu Silim Plaka Poliüretan / Abrading Rubber Plate Polyurethane	100 mm	300 mm	10 mm

BAĞLANTI TAKOZU GRUBU

STONE GRABBING APPARATUS GROUP

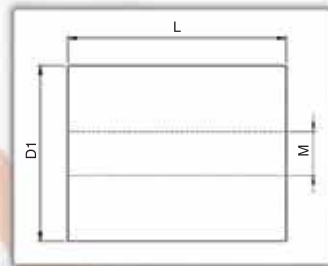

Kod Code	Tanım Description	D1	L	M
311601	Bağlantı Takozu / Stone Grabbing Apparatus	30 mm	40 mm	10 mm
311602	Bağlantı Takozu Vidalı / Stone Grabbing Apparatus Screwed	30 mm	40 mm	10 mm
311603	Bağlantı Takozu / Stone Grabbing Apparatus	40 mm	40 mm	10 mm
311604	Bağlantı Takozu / Stone Grabbing Apparatus	40 mm	40 mm	8 mm
311605	Bağlantı Takozu / Stone Grabbing Apparatus	30 mm	40 mm	8 mm

KAPMA LASTİK GRUBU

GRAB RUBBER GROUP



Kod Code	Tanım Description	En Width	Kalınlık Thickness	Uzunluk Length
310701	Kare Kapma Lastik / Grabbing Rubber	180 mm	22 mm	200 mm
310702	Kare Kapma Lastik / Grabbing Rubber	170 mm	-	250 mm
310703	Kare Kapma Lastik Demirli / Grabbing Rubber Ferrous	120 mm	22 mm	200 mm
310704	Kare Kapma Lastik Baklava Dilimli / Grabbing Rubber in Slices	120 mm	18 mm	180 mm
310705	Oval Kapma Lastik / Oval Grabbing Rubber	150 mm	20 mm	250 mm

PALET LASTİK GRUBU

PALET RUBBER GROUP



Kod Code	Tanım Description	D1	L
311301	Palet Lastik / Palet Rubber	700 mm	745 mm
	Palet Lastik Demirsiz / Palet Rubber Non-Ferrous	700 mm	700 mm
	Palet Lastik Demirli / Palet Rubber Ferrous	700 mm	700 mm

DİZGİ LASTİK GRUBU

STRING RUBBER GROUP

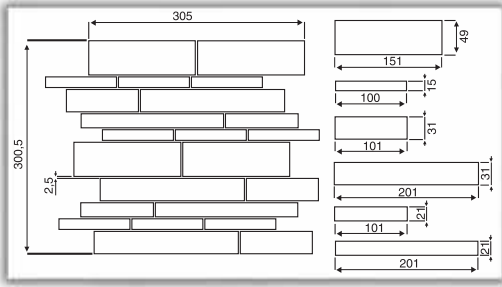

310901

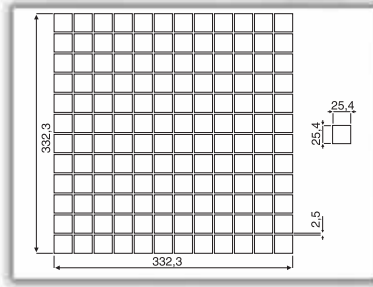

310902

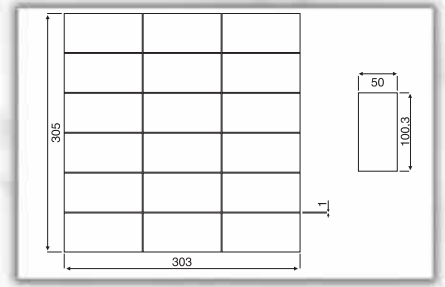

310903

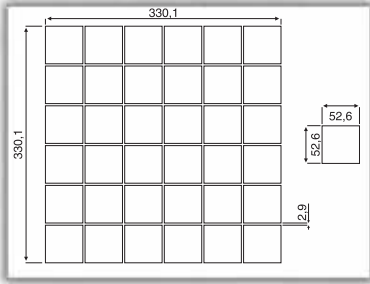

310904

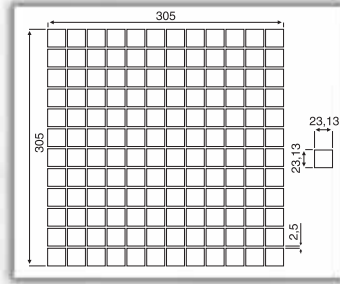

310905

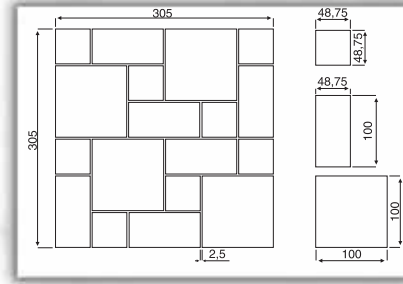

310906

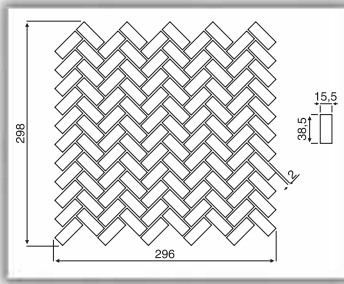

310907

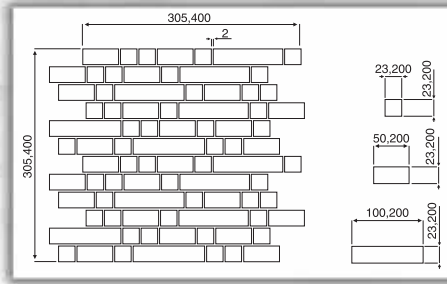

310908

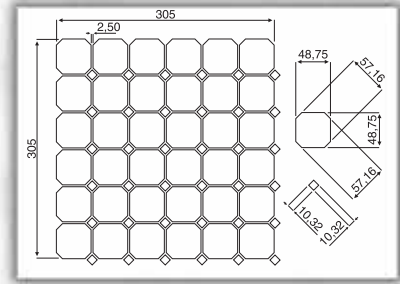

310909

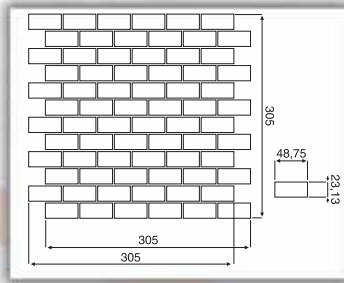

310910

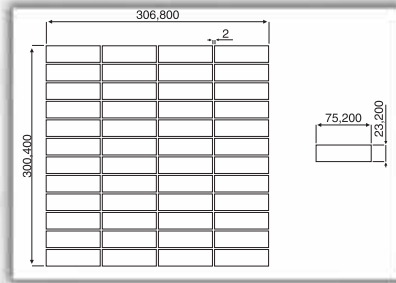

310911

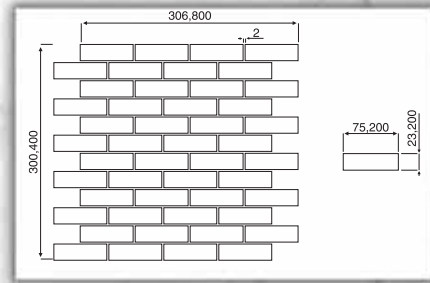

310912

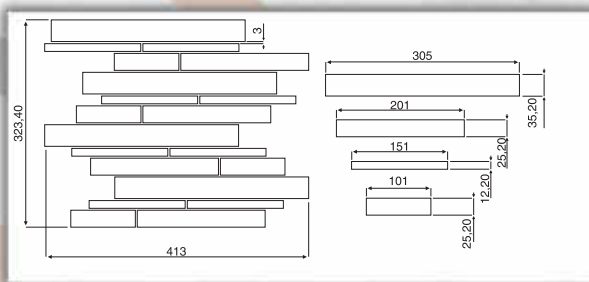

310913

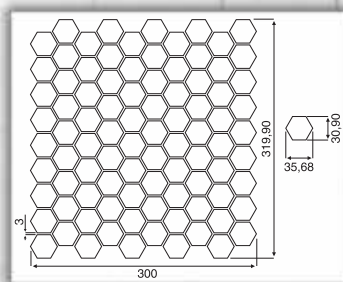

310914

DİZGİ LASTİK GRUBU

STRING RUBBER GROUP

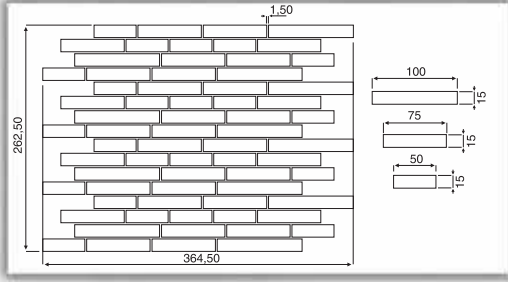

310915

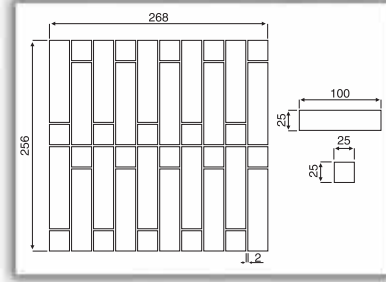

310916

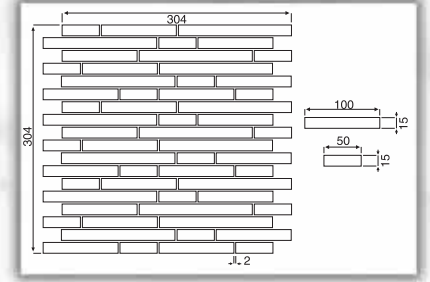

310917

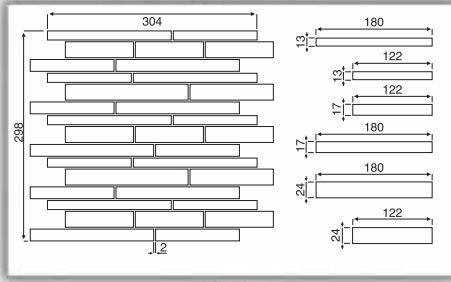

310918

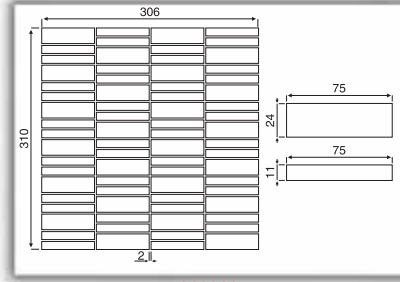

310919

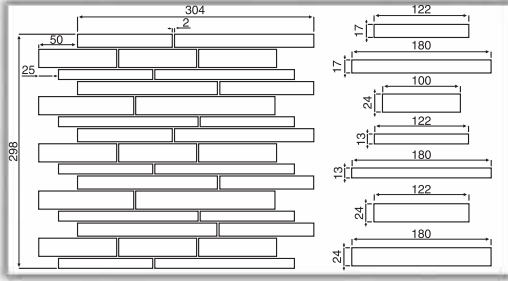

310922

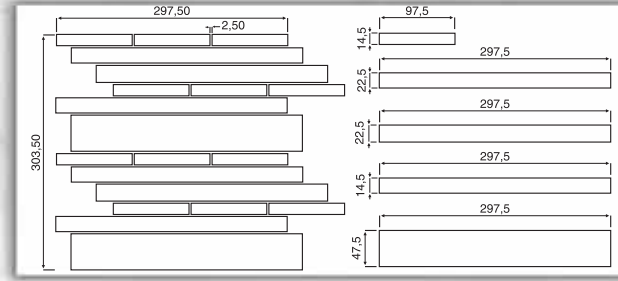

310923

DİZGİ KESİM KALIBI GRUBU

STRING CUTTING RUBBER GROUP

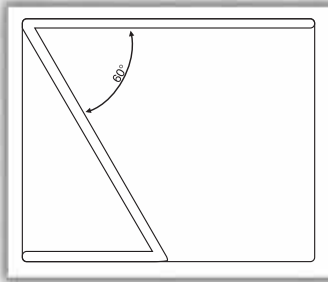

310950

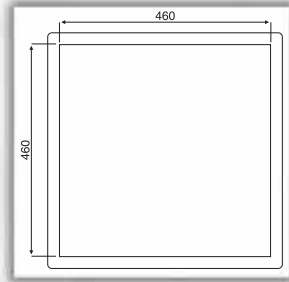

310951

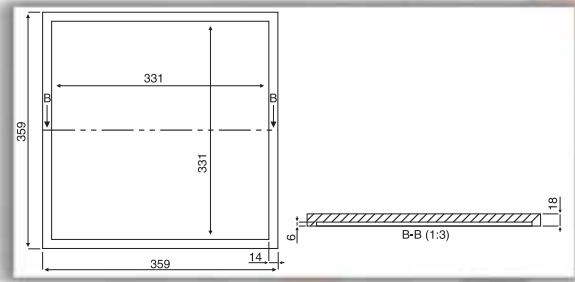

310951

* Talep edilen ölçü ve ebatlarda üretim yapılmaktadır.
* Products can be desired extent size.

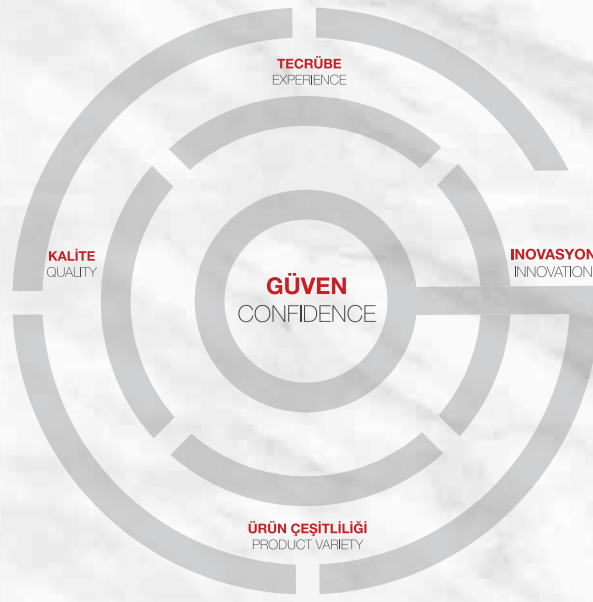

GÜVENAL
LASTİK SAN. VE TİC. LTD. ŞTİ.

İkitelli Organize Sanayi Bölgesi Çevre Sanayi Sitesi 8.Blok No:7-9-11
İkitelli -Başakşehir / İSTANBUL
Tel : +90.02124857894 • Faks: +90.02124857894
E-posta: info@guvenallastik.com